

# K60DT005L Datasheet

## Technical Specifications

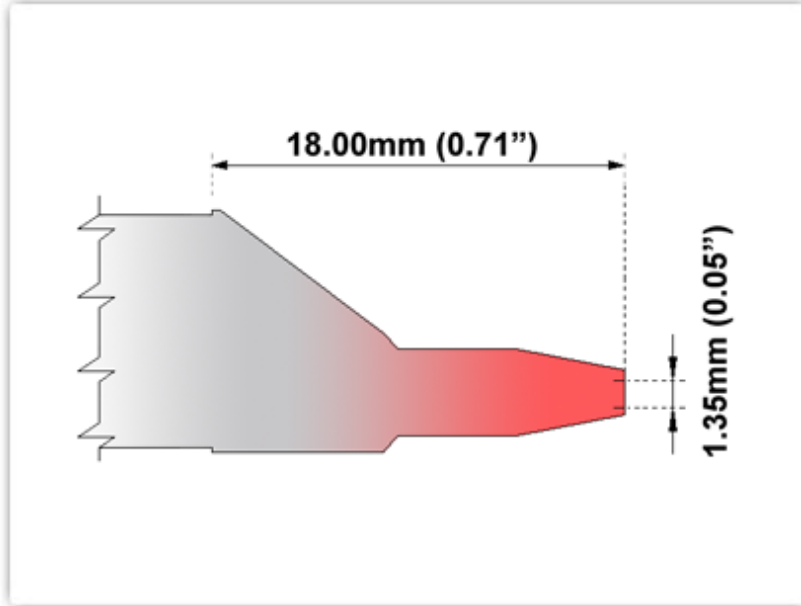

### K60DT005L

**Desoldering Tip - Inner Diameter 1.35mm (0.05"), Long Reach**

Tip Style: Desoldering  
 Tip Width: 1.35mm (0.05")  
 Tip Length: 18.00mm (0.71")

600 Type Cartridge <sup>1</sup> :	325°C - 358°C
RoHS Compliant <sup>2</sup> / Lead Free:	YES
For Use With:	TMT-2000PS, TMT-2000S-K, TMT-2000S-KM, TMT-2000S-P, TMT-2000S-PM, TMT-2000S-SM, TMT-2000S-DT, TMT-2000S-TZ

## Material Composition

## Patented Color Band

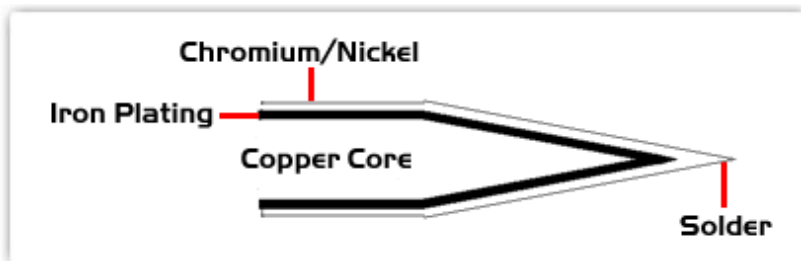

**All components are RoHS compliant and Lead-Free.**

<sup>1</sup> Thermaltronics tip cartridges will typically idle within a temperature range of +/-1.1°C. However, there is variation in idle temperature across tip geometries within an individual temperature series. Thermaltronics offers a wide variety of tip geometries from 0.25mm fine point tip to 5mm chisel. The length and geometry of a tip will have an influence on the tip idle temperature. To accurately measure idle temperature it will depend greatly on the measurement method, technique and equipment used. Two different methods or the use of alternative equipment will produce different test results.

<sup>2</sup> Please refer to <http://www.rohs.gov.uk> for details on RoHS Compliance.