

HTN-BQ100 Datasheet

Technical Specifications

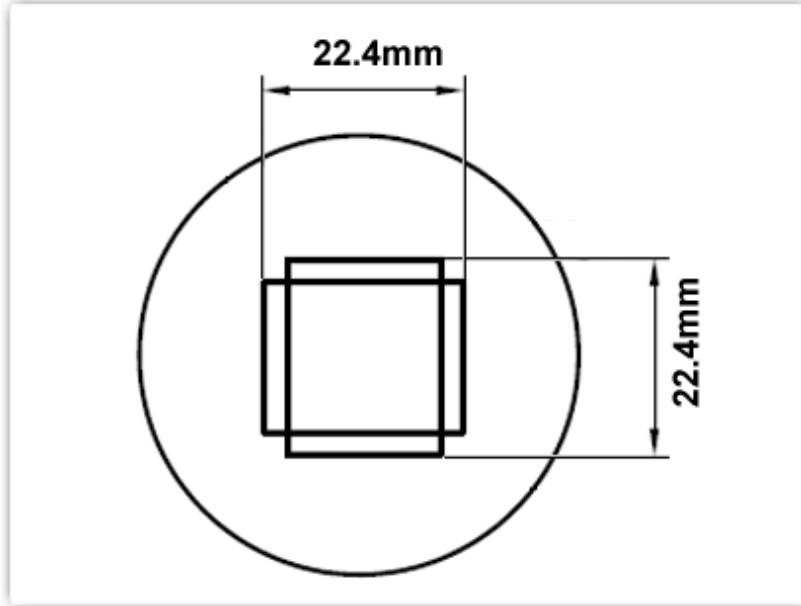

HTN-BQ100

Nozzle 22.4mm x 22.4mm, BQFP-100

Nozzle Style: BQFP-100

Nozzle Width: 22.40mm (0.88")

Nozzle Height: 22.40mm (0.88")

Nozzle Type:	HTN Series
RoHS Compliant / Lead Free:	YES
Equivalent to:	H-BQ23
For Use With:	TMT-HA200, TMT-HA300, HCT-900

Material Composition

Stainless Steel



**All components
are RoHS
compliant and
Lead-Free.**



**Standard Connector
22mm (0.87") diameter**