

HTN-B3939 Datasheet

Technical Specifications

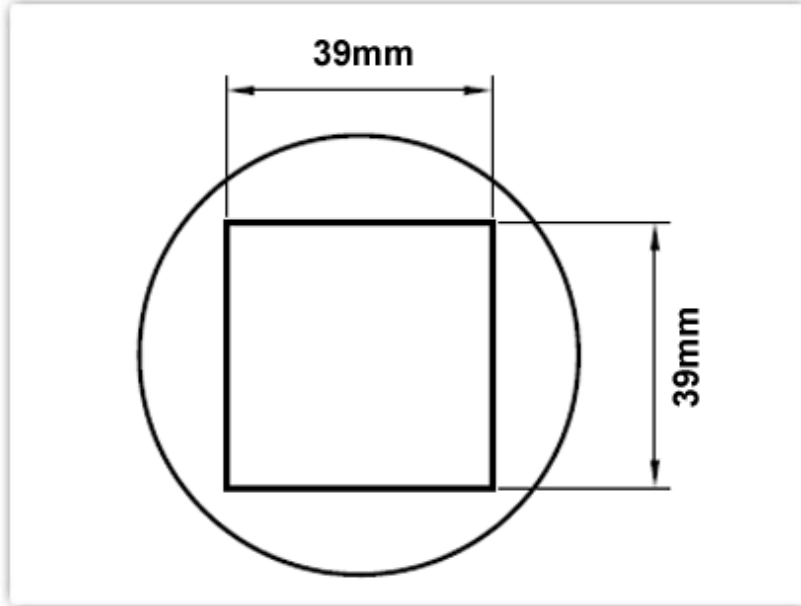

HTN-B3939

Nozzle 39.0mm x 39.0mm, BGA

Nozzle Style: BGA

Nozzle Width: 39.00mm (1.54")

Nozzle Height: 39.00mm (1.54")

Nozzle Type:	HTN Series
RoHS Compliant / Lead Free:	YES
For Use With:	TMT-HA200, TMT-HA300, HCT-900

Material Composition

Stainless Steel



***All components
are RoHS
compliant and
Lead-Free.***

**Standard Connector
22mm (0.87") diameter**