

## HTN-B2828 Datasheet

### Technical Specifications

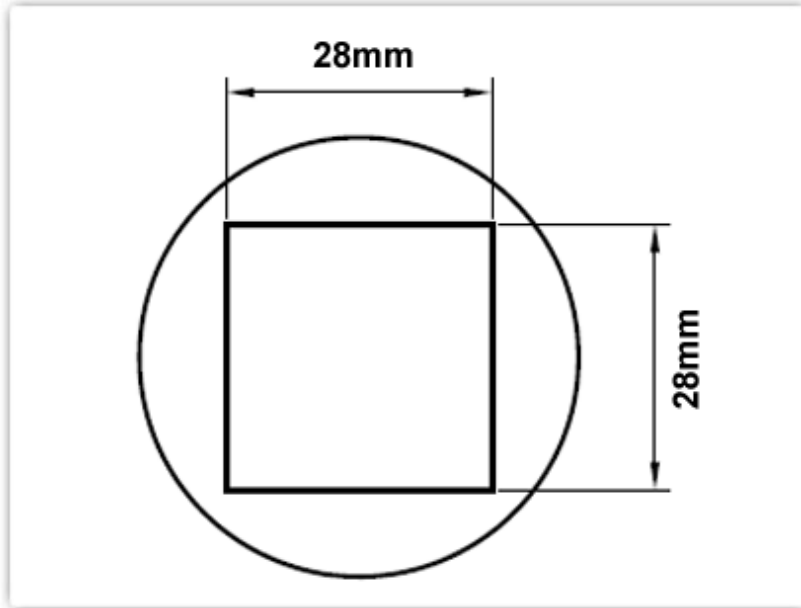

#### HTN-B2828

*Nozzle 28.0mm x 28.0mm, BGA*

Nozzle Style: BGA

Nozzle Width: 28.00mm (1.10")

Nozzle Height: 28.00mm (1.10")

Nozzle Type:	HTN Series
RoHS Compliant / Lead Free:	YES
For Use With:	TMT-HA200, TMT-HA300, HCT-900

### Material Composition

**Stainless Steel**



***All components  
are RoHS  
compliant and  
Lead-Free.***



**Standard Connector  
22mm (0.87") diameter**